

Article number: 20115030SW14FHE

Description: E+G Stainless steel latch GN 1150-FH-E  
Hygienic Design

## Measures

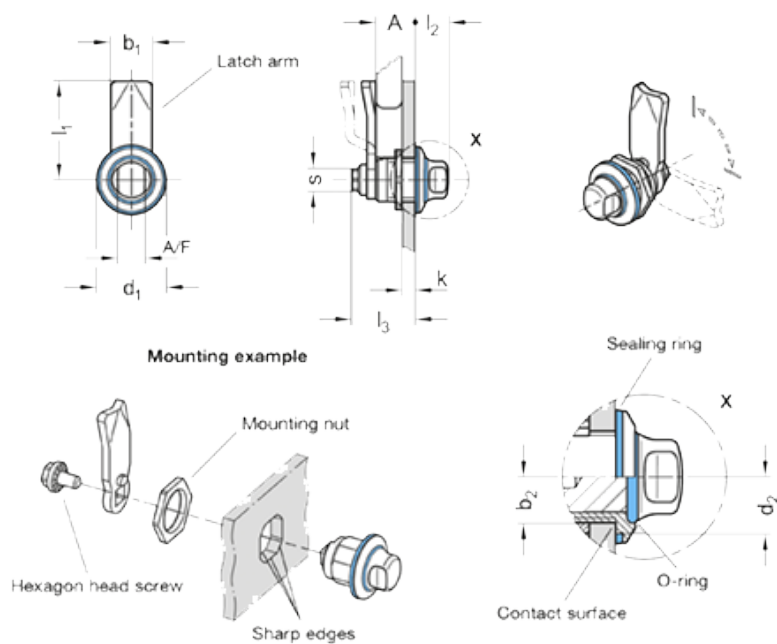

A/F = 13	l3 = 29
b1 = 19	kmin = 1.5
b2 = 10	la = 14
d1 = 30	s = 10
d2 = 13	
g = 125	
l1 = 45	
l2 = 15.3	